

DATI TECNICI

| | | | |
|---|--------------------------|---|------------------------|
| Potenza termica globale (max. - min.) | 12,4 - 3,5 kW | Depressione canna fumaria (max. - min.) | 11,4 - 9,8 Pa |
| Potenza nominale (max. - min.) | 11,4 - 3,4 kW | Peso | 115 kg |
| Rendimento (max. - min.) | 92,2 - 96,2 % | Dimensioni LxPxH | 704x550x1030 mm |
| Temperatura dei fumi (max. - min.) | 183,4 - 72,7 °C | Dimensioni tubo canalizzazione | ø 80 mm |
| Capacità serbatoio pellet | 18 kg | Dimensione uscita fumi | ø 80 mm |
| Consumo orario (max. - min.) | 2,5 - 0,73 kg/h | Uscita fumi | Posteriore |
| Volume riscaldabile (indicativo) | 320 m³ | | |
| Autonomia (max. - min.) | 7,2 - 25,7 h | | |
| Emissioni CO (13% O ₂) (max. - min.) | 89 - 664 mg/m³ | | |
| Emissioni NOx (13% O ₂) (max. - min.) | 146 - 135 mg/m³ | | |
| Emissioni OGC (13% O ₂) (max. - min.) | 2,1 - 12,9 mg/m³ | | |
| Emissioni polveri (13% O ₂) (max. - min.) | 14,6 - 25,1 mg/m³ | | |
| Massa fumi (max. - min.) | 5,2 - 2,4 g/s | | |

DOTAZIONI

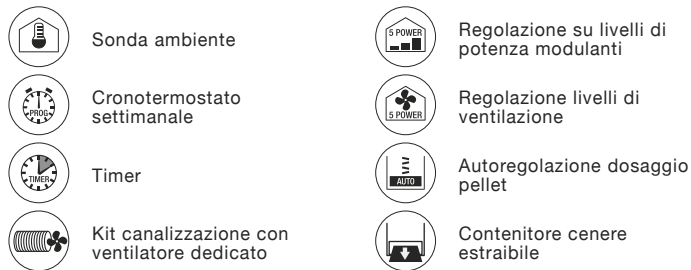

OPTIONAL



DIMENSIONI ED INGOMBRI

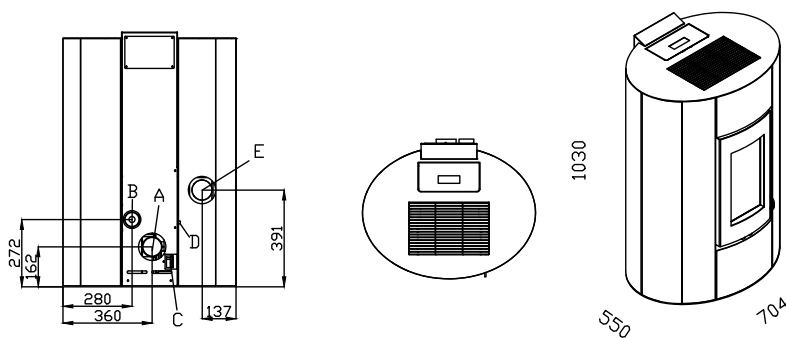

- A** Scarico fumi ø 80 mm
- B** Aspirazione aria ø 60 mm
- C** Interruttore on/off
- D** Termostato a riarmo manuale
- E** Uscita canalizzazione ø 80 mm

CERTIFICAZIONI

| | | |
|-------------------|------------------|------------------------|
| EN 14785:2006 | German BIMSChv | Flamme Verte (7 stars) |
| Austrian 15a B-VG | Swiss TRV Limits | |

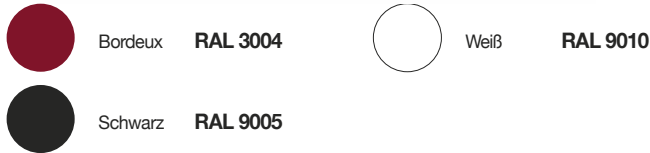

TECHNISCHE DATEN

| | | | |
|---|--------------------------|----------------------------------|----------------------------|
| Brennstoffwärmeleistun (max. - min.) | 12,4 - 3,5 kW | Mindestförderdruck (max. - min.) | 11,4 - 9,8 Pa |
| Nennwärmeleistung (max. - min.) | 11,4 - 3,4 kW | Gewicht | 115 kg |
| Wirkungsgrad (max. - min.) | 92,2 - 96,2 % | BemaßungLxPxH | 704x550x1030 mm |
| Abgastemperatur (max. - min.) | 183,4 - 72,7 °C | Bemaßungtubo canalizzazione | ø 80 mm |
| Inhalt Pelletbehälter | 18 kg | Rauchabzug | ø 80 mm |
| Stundenverbrauch (max. - min.) | 2,5 - 0,73 kg/h | Rauchabzug | Abgasstutzen Hinten |
| Raumheizvermöge | 320 m³ | | |
| Betriebsautonomie (max. - min.) | 7,2 - 25,7 h | | |
| Emissionen CO (13% O ₂) (max. - min.) | 89 - 664 mg/m³ | | |
| Emissionen NOx (13% O ₂) (max. - min.) | 146 - 135 mg/m³ | | |
| Emissionen OGC (13% O ₂) (max. - min.) | 2,1 - 12,9 mg/m³ | | |
| Feinstaubinhalt (13% O ₂) (max. - min.) | 14,6 - 25,1 mg/m³ | | |
| Abgasmassenstrom (max. - min.) | 5,2 - 2,4 g/s | | |

AUSRÜSTUNG

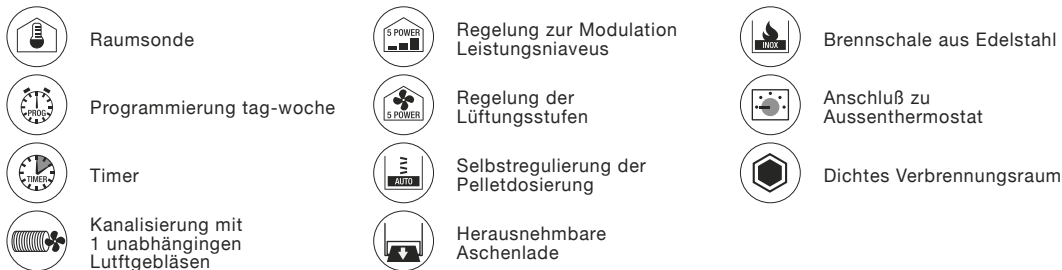

OPTIONAL



GRÖSSE

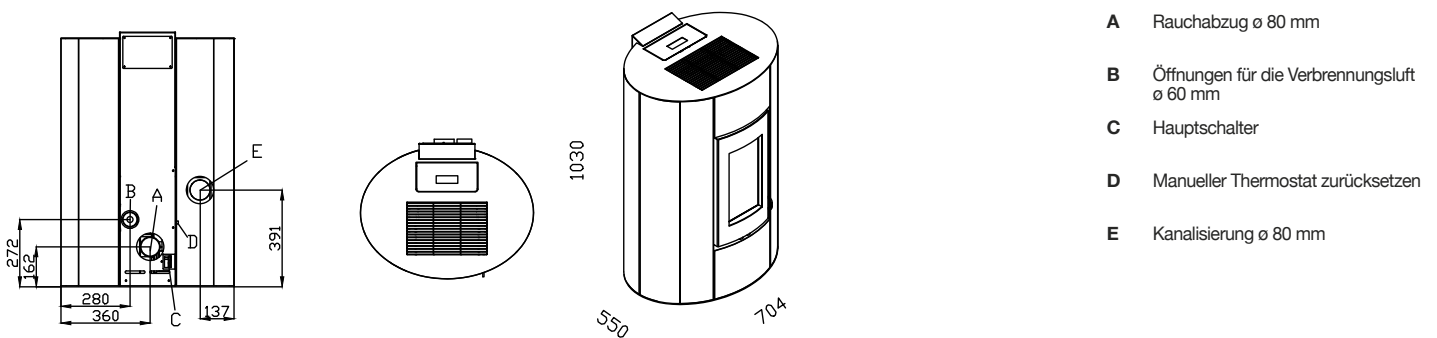

ZERTIFIZIERUNGEN

| | | |
|-------------------|------------------|------------------------|
| EN 14785:2006 | German BIMSChv | Flamme Verte (7 stars) |
| Austrian 15a B-VG | Swiss TRV Limits | |

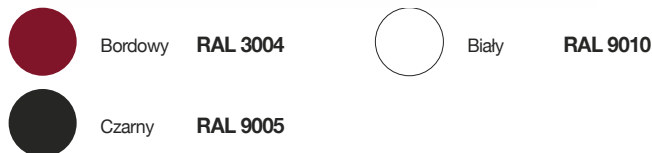

DANE TECHNICZNE

| | | | |
|---|--------------------------|-----------------------------|---------------------------|
| Wprowadzona moc cieplna (max. - min.) | 12,4 - 3,5 kW | Ciąg kominowy (max. - min.) | 11,4 - 9,8 Pa |
| Moc grzewcza całkowita (max. - min.) | 11,4 - 3,4 kW | Waga | 115 kg |
| Sprawność (max. - min.) | 92,2 - 96,2 % | Wymiary LxPxH | 704x550x1030 mm |
| Średnia temperatura spalin (max. - min.) | 183,4 - 72,7 °C | Wymiary rury kanalowej | ø 80 mm |
| Pojemność zbiornika | 18 kg | Ujście dymów | ø 80 mm |
| Zużycie paliwa moc (max. - min.) | 2,5 - 0,73 kg/h | Ujście dymów | Wylot spalin tylny |
| Objętość ogrzewalna (indicativo) | 320 m³ | | |
| Autonomia pracy (max. - min.) | 7,2 - 25,7 h | | |
| Emisja CO (13% O ₂) (max. - min.) | 89 - 664 mg/m³ | | |
| Emisja NOx (13% O ₂) (max. - min.) | 146 - 135 mg/m³ | | |
| Emisja OGC (13% O ₂) (max. - min.) | 2,1 - 12,9 mg/m³ | | |
| Emisja pyłu (13% O ₂) (max. - min.) | 14,6 - 25,1 mg/m³ | | |
| Masowy przepływ oparów (max. - min.) | 5,2 - 2,4 g/s | | |

EQUIPAMIENTO

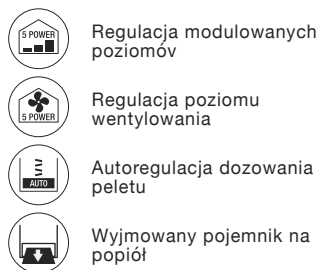

OPTIONAL



WYMIARY

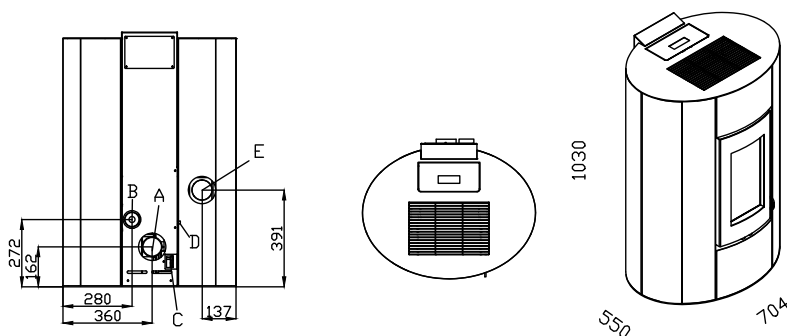

- A** Ujście dymu ø 80 mm
- B** Chwyt powietrza do spalania ø 60 mm
- C** Wyłącznikiem
- D** Termostat z ręcznym resetem
- E** Uscita canalizzazione ø 80 mm

CERTYFIKATY

EN 14785:2006

German BIMSChv

Flamme Verte (7 stars)

Austrian 15a B-VG

Swiss TRV Limits